

M97-AH
Stereo DYNETIC[®]
Integrated
Cartridge-Headshell
Series

ERA IV

 **SHURE[®]**

M97-AH INTEGRATED CARTRIDGE WITH ADJUSTABLE OVERHANG

The Model M97-AH series are integrated cartridges and headshells with universal SME-type bayonet headshell connectors for instant attachment to many of the world's finest tone arms and turntables. The integrated design with adjustable overhang provides the major advantage of a total weight reduction of 4 to 6 grams compared to a separate cartridge and headshell. A further advantage is the simplicity of the plug-in connection, eliminating the bother of tiny screws, nuts, terminals, and wires, as well as much of the weight associated with these parts. This integrated cartridge-headshell series has all the ERA IV features of the M97 cartridges—including the Dynamic Stabilizer and telescoped shank—along with the exclusive Shure SIDE-GUARD stylus protection of the M97 Series. A unique non-operable alignment stylus provided for use when setting overhang considerably simplifies this procedure for minimizing lateral tracking error.

The M97-AH integrated series is available in two versions:

Model M97HE-AH with a distortion-reducing hyperelliptical nude stylus tip; for ultralight tip tracking forces of 0.75 to 1.5 grams;

Model M97EJ-AH with a biradial (elliptical) stylus tip; for light tip tracking forces of 1.5 to 3.0 grams.

ERA IV features of the M97-AH

A viscous-damped Dynamic Stabilizer

- Ignores warp effects by accommodating sudden changes in motion;
- maintains a constant distance from the tone arm to the record;
- preserves a constant vertical tracking angle and tracking force;

OTHER CARTRIDGE

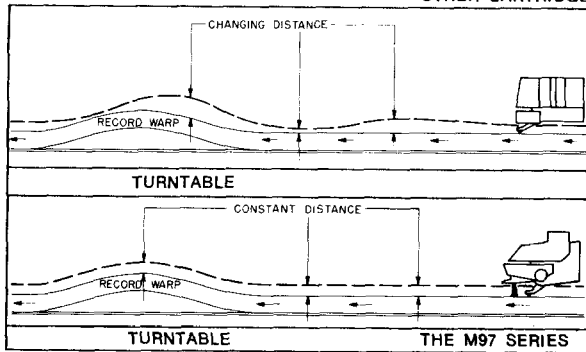

- reduces the sensitivity of the tone arm-cartridge system to its natural resonance frequency;
- helps raise the resonance frequency above the warp-frequency range;

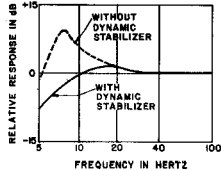

Typical Tone Arm-Cartridge Characteristics

FIGURE 2

- has conductive fibers to conduct record-surface static charges to ground, and to reach down into the record groove to sweep away interfering dust and dirt;

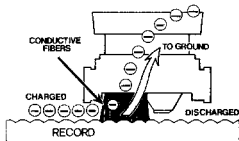

FIGURE 3

- acts to absorb the shock and to protect the stylus when an arm is accidentally dropped on the record.

A telescoped shank

- improves the ruggedness of the moving system without increasing its effective mass;

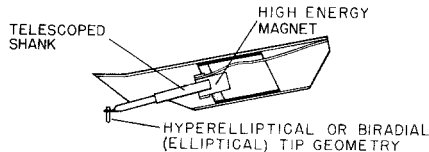

FIGURE 4

- helps improve mid- and high-frequency trackability.

Shure SIDE-GUARD deflection assembly

SIDE-GUARD responds to side thrusts on the stylus by withdrawing the entire stylus shank and tip safely into the stylus housing before they can be damaged.

Arrows show direction of stylus subjected to sudden lateral motion

Front view of SIDE-GUARD deflection assembly and stylus

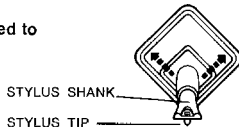

FIGURE 5

Adjustable overhang

An accessible adjustment locking screw on top of the integrated headshell

- permits setting stylus overhang optimally to minimize lateral tracking error for each individual tone arm or turntable;
- is locked with the supplied hexagon wrench;
- adjusts the stylus tip-to-connector distance from 46 mm minimum to 53 mm maximum.

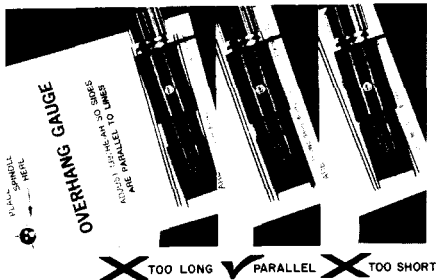

FIGURE 6

An alignment stylus is supplied to simplify the overhang-setting procedure. An overhang gauge is supplied for users who lack a gauge or guide for their tone arms or turntables.

INSTALLATION AND OPERATION

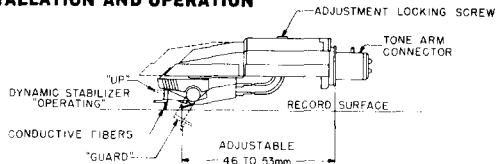

FIGURE 7

Stylus removal and replacement



FIGURE 8

IMPORTANT: Place the Dynamic Stabilizer in the "guard" position during stylus removal and replacement. Exercise care so your fingers don't slip and damage the stylus tip or shank. Protect the stylus with the Dynamic Stabilizer in the "guard" position before attaching the integrated headshell to the tone arm. Use the alignment stylus when setting overhang.

Setting overhang

With the alignment stylus inserted in the cartridge body, use the supplied hexagon wrench to loosen the screw on top of the integrated headshell. Use your tone arm or turntable overhang gauge (or, if you lack one, the gauge supplied with the M97-AH) to set the stylus overhang to the required distance. Tighten the screw and check that the overhang is correct. Replace the alignment stylus with the playing stylus.

Setting tracking force

WITH THE DYNAMIC STABILIZER OPERATING

The M97HE-AH is designed for a stylus tip tracking force of 0.75 to 1.5 grams; the M97EJ-AH is designed for a stylus tip tracking force of 1.5 to 3.0 grams. When the viscous-damped Dynamic Stabilizer is in the operating position (see Figure 7), it exerts a force on the record of 0.5 grams that must also be accommodated in the total tone arm tracking force setting.

Therefore, use the following settings.

To obtain this force at the stylus tip	Set the arm tracking force adjustment to
0.75 grams	1.25 grams
1.0 gram	1.5 grams
1.5 grams	2.0 grams
2.0 grams	2.5 grams
3.0 grams	3.5 grams

When using an external gauge, such as the Shure SFG-2 Stylus Force Gauge, for setting tracking force, lock the Dynamic Stabilizer in the "up" position, and set the tracking force as shown in the second column. (When the Dynamic Stabilizer rides on the record surface with the cartridge in use, the extra 0.5 grams will be offset by the Stabilizer and WILL NOT APPEAR AT THE STYLUS TIP. The tip force will be that shown in the first column.)

WITH THE DYNAMIC STABILIZER UP

If, for any reason, the cartridge is used with the Dynamic Stabilizer in the "up" position, the tracking force should be set as recommended for the tip, i.e., from 0.75 to 1.5 grams or from 1.5 to 3.0 grams.

NOTE: Do not exceed the maximum tracking forces of 2.0 grams or 3.5 grams when the cartridge is used with the Dynamic Stabilizer "operating", or 1.5 grams or 3.0 grams when used with the Stabilizer "up".

Setting antiskating force

Set the antiskate mechanism according to the tone arm manufacturer's directions. Use an antiskating force corresponding to the total tone arm tracking force setting (column 2 in chart above).

Operation

Before playing the first record, carefully place the Dynamic Stabilizer in the "operating" position so that it floats below the cartridge. The M97-AH is now ready to use. For manual play, the white cue stripe (see Figure 9) on the Dynamic Stabilizer assists in accurate set-down by showing the stylus tip position.

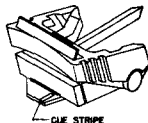

FIGURE 9

M97EJ-AH only:

Some tone arms require additional mass to counterbalance. Insert the supplied weight as shown in Figure 10.

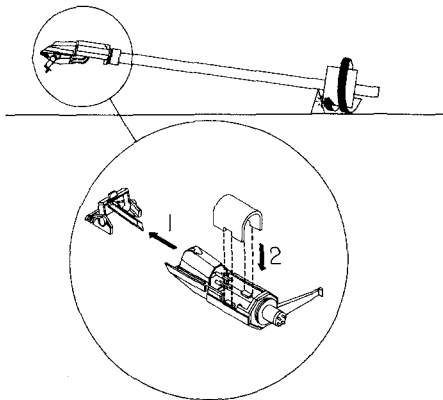

FIGURE 10

CLEANING

For best performance, clean the fibers of the Dynamic Stabilizer and the stylus tip regularly.

Cleaning the Dynamic Stabilizer

Use the supplied brush. **Use no fluids.** Carefully clean the dust out of the fibers using a back to front movement. Brush the fibers long enough to remove the fine particles between the fibers as well as any mat of lint on the surface. Take care not to catch the stylus shank or tip when cleaning the Dynamic Stabilizer brush.

Cleaning the stylus tip

Use the supplied brush. Always brush the stylus from back to front; never brush or wipe the stylus from front to back or side to side. Alcohol or a solution of alcohol and distilled water can be used as a cleaning agent. Take care that the stylus cleaning fluid is not applied to the Stabilizer fibers. Commercial cleaning solutions may cause stylus damage or corrosion.

SPECIFICATIONS

Frequency Response

20 to 20,000 Hz.

Output (at 1,000 Hz)

4.0 mV at 5 cm/sec peak recorded velocity (output voltage given for stereo cut record. For Mono cut record, output voltage at both left and right channel cartridge terminals will be 71% of above figure.)

Inductance

700 millihenries

DC Resistance

1550 ohms

Optimum Load

47,000 ohms resistance in parallel with 200 to 300 picofarads capacitance per channel. Load resistance can be up to 70,000 ohms with almost no audible change in frequency response. Total capacitance includes both tone arm wiring and amplifier input circuit.

Channel Balance

Within 2 dB

Channel Separation (minimum)

M97HE-AH: 25 dB at 1 kHz; M97EJ-AH: 20 dB at 1 kHz

Net Weight

12.6 grams

Tracking Force

	<u>Force at the stylus tip</u>	<u>Total tone arm setting with Dynamic Stabilizer operating</u>
M97HE-AH		
	Minimum 0.75 grams	1.25 grams
	1.0 gram	1.5 grams
	Maximum 1.5 grams	2.0 grams
M97EJ-AH		
	Minimum 1.5 grams	2.0 grams
	2.0 grams	2.5 grams
	Maximum 3.0 grams	3.5 grams

Typical Trackability (in cm/sec peak recorded velocity)

<u>M97HE-AH at 1 gram tip tracking force</u>	<u>M97EJ-AH at 2 grams tip tracking force</u>
400 Hz—24 cm/sec	400 Hz—30 cm/sec
1,000 Hz—35 cm/sec	1,000 Hz—41 cm/sec
5,000 Hz—33 cm/sec	5,000 Hz—46 cm/sec
10,000 Hz—25 cm/sec	10,000 Hz—34 cm/sec

Replacement Styli

N97HE, hyperelliptical nude diamond tip
N97EJ, 10x18 μ (.0004x.0007 in.) biradial (elliptical) diamond tip

Optional 78 rpm Stylus

N978E, 13x63 μ (.0005x.0025 in.) biradial (elliptical) diamond tip; tip tracking force: 1.5 to 3.0 grams; total tone arm force with Dynamic Stabilizer operating: 2.0 to 3.5 grams

PRESERVING STYLUS LIFE

1. Follow turntable or tone arm instructions when adjusting antiskating force in tone arm suspension system.
2. Do not handle tone arm while it is in operation since this may cause arm to sweep across record.
3. If necessary to manually place tone arm in record groove while turntable is rotating, release arm as Dynamic Stabilizer sets down on record or as stylus engages record groove.
4. Correct improper setdown adjustment or malfunction of turntable changing mechanism to prevent stylus from striking edge of turntable or record. Do not stack more records than turntable manufacturer recommends.
5. Take care to properly insert stylus into cartridge assembly and cartridge and shell assembly into tone arm receptacle.
6. Use proper vertical tracking force setting for each cartridge.
7. Do not use damaged records.
8. When dusting turntable, protect stylus with Dynamic Stabilizer locked in "guard" position.

SPECIAL NOTE

To maintain the original performance standards of your cartridge, be certain that any replacement stylus you buy bears the following certification on the package: "This Stereo Dynetic® stylus is precision manufactured by Shure Brothers Inc." **AVOID INFERIOR IMITATIONS. THEY WILL SERIOUSLY DEGRADE THE PERFORMANCE OF YOUR CARTRIDGE. ALL GENUINE "DYNETIC®" STYLUS ARE MANUFACTURED BY SHURE BROTHERS INC. LOOK FOR THE NAME SHURE ON THE STYLUS GRIP. For more information on your Shure stylus, write for pamphlet: "Don't be penny-wise and sound foolish." (AL633)**

PATENT NOTICE

Cartridge and stylus manufactured under one or more of the following U.S. Patents: 3,055,988, 3,077,521, 3,077,522, and 3,463,889. Other patents pending.

FULL ONE-YEAR WARRANTY

Shure Brothers Incorporated ("Shure"), 222 Hartrey Avenue, Evanston, Illinois 60204, warrants to the owner of this product that it will be free, in normal use, of any defects in workmanship and materials for a period of one year from date of purchase. You should retain proof of date of purchase. Shure is not liable for any consequential damages. If this Shure product has any defects as described above, carefully repack the unit and return it prepaid to:

Shure Brothers Incorporated
Attention: Service Department
1501 West Shure Drive
Arlington Heights, Illinois 60004

If you are not in the United States, return the unit to your dealer or Authorized Service Center for repair. The unit will be repaired or replaced and returned to you promptly and, if it cannot be repaired or replaced, you may elect to receive a refund. This warranty does not include stylus wear.

Copyright 1981, Shure Brothers Inc.

27A1637 (UB)

Printed in U.S.A.