



## Wireless Antenna Combiner User Guide

Guide de l'utilisateur du répartiteur d'antenne sans fil

Bedienungsanleitung für die drahtlose Antennenweiche

Guía del usuario del combinador de antenas inalámbrico

Guida d'uso del combinatore di antenne senza fili



**! IMPORTANT SAFETY INSTRUCTIONS !**

1. READ these instructions.
2. KEEP these instructions.
3. HEED all warnings.
4. FOLLOW all instructions.
5. DO NOT use this apparatus near water.
6. CLEAN ONLY with dry cloth.
7. DO NOT block any ventilation openings. Install in accordance with the manufacturer's instructions.
8. DO NOT install near any heat sources such as radiators, heat registers, stoves, or other apparatus (including amplifiers) that produce heat.
9. DO NOT defeat the safety purpose of the polarized or grounding-type plug. A polarized plug has two blades with one wider than the other. A grounding type plug has two blades and a third grounding prong. The wider blade or the third prong are provided for your safety. If the provided plug does not fit into your outlet, consult an electrician for replacement of the obsolete outlet.
10. PROTECT the power cord from being walked on or pinched, particularly at plugs, convenience receptacles, and the point where they exit from the apparatus.
11. ONLY USE attachments/accessories specified by the manufacturer.

12.  USE only with a cart, stand, tripod, bracket, or table specified by the manufacturer, or sold with the apparatus. When a cart is used, use caution when moving the cart/apparatus combination to avoid injury from tip-over.
13. UNPLUG this apparatus during lightning storms or when unused for long periods of time.
14. REFER all servicing to qualified service personnel. Servicing is required when the apparatus has been damaged in any way, such as power-supply cord or plug is damaged, liquid has been spilled or objects have fallen into the apparatus, the apparatus has been exposed to rain or moisture, does not operate normally, or has been dropped.
15. DO NOT expose the apparatus to dripping and splashing. DO NOT put objects filled with liquids, such as vases, on the apparatus.
16. The MAINS plug or an appliance coupler shall remain readily operable.
17. The airborne noise of the apparatus does not exceed 70dB (A).
18. Apparatus with CLASS I construction shall be connected to a MAINS socket outlet with a protective earthing connection.
19. To reduce the risk of fire or electric shock, do not expose this apparatus to rain or moisture.
20. Do not attempt to modify this product. Doing so could result in personal injury and/or product failure.



This symbol indicates that dangerous voltage constituting a risk of electric shock is present within this unit.



This symbol indicates that there are important operating and maintenance instructions in the literature accompanying this unit.

**WARNING:** Voltages in this equipment are hazardous to life. No user-serviceable parts inside. Refer all servicing to qualified service personnel. The safety certifications do not apply when the operating voltage is changed from the factory setting.

**DESCRIPTION**

Shure PA Series UHF Antenna Combiners combine antenna outputs from up to four PSM wireless transmitters to a single antenna, minimizing intermodulation distortion and reducing rack clutter.

**CONNECTIONS**

1. Using the cables supplied with each PSM Transmitter, connect the ANTENNA OUT of each PSM Transmitter to the INPUTS of the PA Antenna Combiner.
2. Attach the antenna (one supplied with each PSM Transmitter), or an optional directional antenna such as the Shure Model PA805WB, to the ANTENNA OUT connector of the PA Antenna Combiner.
3. Run the supplied power cable from the power connector to a power supply.

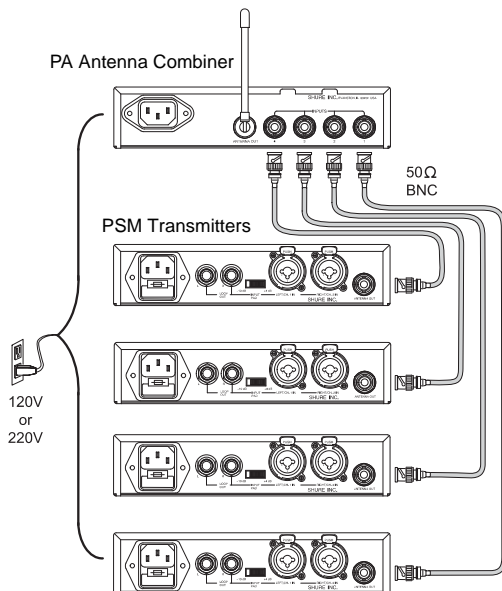

**SPECIFICATIONS**

**UHF Carrier Frequency Range**

Model Number	Frequency Range
PA760	620 to 670 MHz
PA765	800 to 870 MHz
PA770	720 to 750 MHz

**System Gain**

0 dB (+2 dB, -4 dB)

**Input/Output Port VSWR**

Less than 1.7:1

**Output Port Isolation**

Greater than 23 dB

**Third Order Intercept Point (3 OIP)**

Greater than 25 dBm

**Input AC Line Voltage**

100 to 240 Vac, 50/60 Hz (country dependent)

**NOTE:** This product is not completely disconnected from the mains when the power switch is in OFF position.

**Maximum Input Current**

0.5 Aac

**Maximum RF Input Power**

+20 dBm (100 mW)

**Impedance**

50 Ω nominal

**Operating Temperature Range**

-7° C to +49° C

**Overall Dimensions**

44.5 mm high x 197.4 mm wide x 225.6 mm deep  
(1.75 in. x 7.770 in. x 8.880 in.)

**Net Weight**

1.34 Kg (2 lbs, 15.4 oz)

**Input/Output Connector Type**

BNC-type (4 input, 1 output)

**Furnished Accessories**

Rack Mount Kit.....	PA745
2 ft. Coaxial Cable (RG-58/U) .....	UA802

**Optional Accessories**

Unidirectional Antenna (620-870 MHz).....	PA805WB
2 ft. Coaxial Cable (RG-58/U) .....	UA802
10 ft. Coaxial Cable (RG-58/U) .....	PA725
25 ft. Coaxial Cable (RG-8/X) .....	UA825
50 ft. Coaxial Cable (RG-8/X) .....	UA850

**Replacement Parts**

Bulkhead Adapters.....	95A8647
120 VAC Power Line Cord .....	95A8389
230 VAC Power Line Cord .....	95A8247
240# VAC Power Line Cord (U.K.).....	95A8713

**Certifications**

PA760, PA770: Type accepted under FCC Part 74. Certified by IC in Canada under RSS-123. UL and cUL listed to UL813 and CSA 22.2 No. 1.

PA760, PA765, PA770: Conforms to European Union Low Voltage Directive (2006/95/EC) and EMC Directive (89/336/EEC), eligible to bear CE marking. Meets Low Voltage Requirements: VDE

**RACK MOUNTING OPTIONS**

**RACK MOUNTING THE PA ANTENNA COMBINER**

**WARNING:** Do not torque the screws too tightly, or the chassis may be damaged.

**Single Unit**

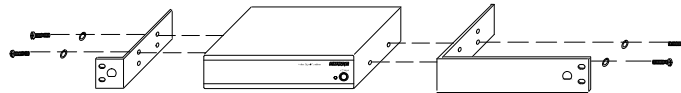

1. Remove the screws and washers from each side of the unit.
2. Align the supplied rackmount brackets over the holes.
3. Using the screws and washers from step 1, fasten the rackmount brackets.

**Dual-Mounted Units**

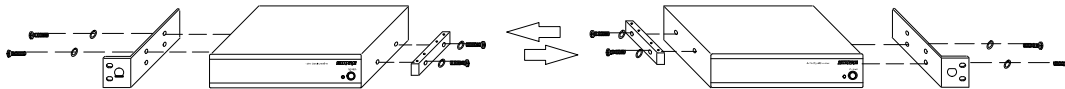

1. Remove the screws and washers on each side of both units.
2. Placing the two units side-by-side, screw the link bars to the inside panels of each unit. The units are designed so that the link bar on the right unit will fit directly on top of the link bar of the left unit (facing front). Use two of the screws and washers from step 1 per link bar to fasten them.
3. Align the rackmount brackets on the outside panels of the units and fasten using four of the screws and washers from step 1.

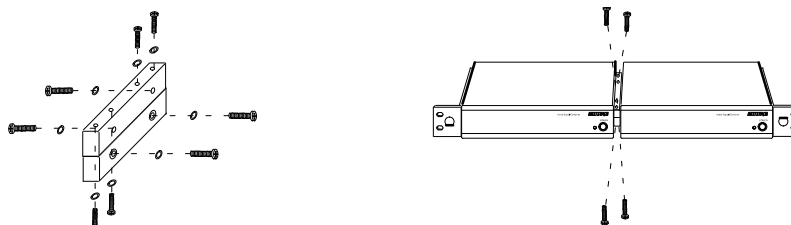

4. Place the two units next to each other so the link bars overlap and the screw holes on the two align.
5. Fasten the link bars together using 4 supplied screws and washers.

GS-Certified to EN 60065. Meets EMC Emission and Immunity Requirements: EN 300 445. Meets the essential requirements of the European R&TTE Directive 99/5/EC and are eligible to carry the CE marking.

**Licensing**

Changes or modifications not expressly approved by Shure Incorporated could void your authority to operate the equipment. Licensing of Shure wireless microphone equipment is the user's responsibility, and licensability depends on the user's classification and application, and on the selected frequency. Shure strongly urges the user to contact the appropriate telecommunications authority concerning proper licensing, and before choosing and ordering frequencies.

THIS RADIO EQUIPMENT IS INTENDED FOR USE IN PROFESSIONAL ENTERTAINMENT AND SIMILAR APPLICATIONS.

**NOTE: THIS EQUIPMENT MAY BE CAPABLE OF OPERATING ON SOME FREQUENCIES NOT AUTHORIZED IN YOUR REGION. PLEASE CONTACT YOUR NATIONAL AUTHORITY TO OBTAIN INFORMATION ON AUTHORIZED FREQUENCIES FOR WIRELESS MICROPHONE PRODUCTS IN YOUR REGION.**

**Licensing:** Note that a ministerial license to operate this equipment may be required in certain areas. Consult your national authority for possible requirements.

## Mounting in an Equipment Rack

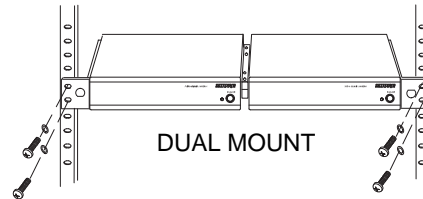
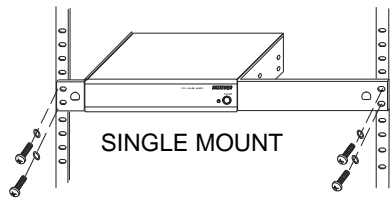

1. Insert the unit (s) into a 19-inch equipment rack.
2. Fasten the unit(s) to the rack using all four of the supplied screws.

### FRONT MOUNTING THE ANTENNA

The PA Antenna Combiner comes equipped so the antenna can be front-mounted. Front-mounting prevents antenna cables from becoming entangled and greatly minimizes RF interference from other cables. When a unit is located in a rack, antennas should be either front- or remote-mounted.

1. Insert the bulkhead adapter through the hole of either mounting bracket, and secure it from the back using the supplied hardware.
2. Connect the transmitter antenna output to the bulkhead adapter with the supplied RF cable.

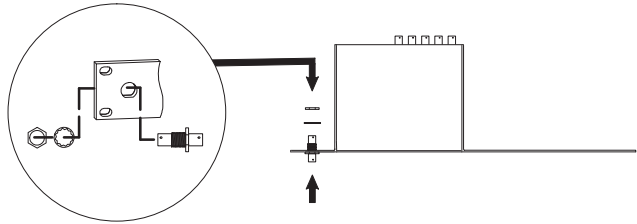

3. Install the antenna on the bulk-head adapter.

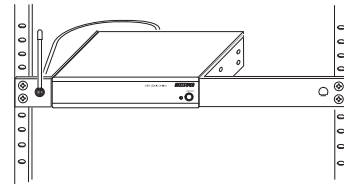
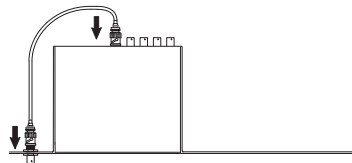

**NOTE:** The PA715 antenna, which comes supplied with the PSM transmitters, cannot be remote mounted. Use a PA805WB antenna for remote mounting.

### Information to User

This equipment has been tested and found to comply with the limits for a Class B digital device, pursuant to Part 15 of the FCC Rules. These limits are designed to provide reasonable protection against harmful interference in a residential installation. This equipment generates, uses and can radiate radio frequency energy and, if not installed and used in accordance with the instructions, may cause harmful interference to radio communications. However, there is no guarantee that interference will not occur in a particular installation. If this equipment does cause harmful interference to radio or television reception, which can be determined by turning the equipment off and on, the user is encouraged to try to correct the interference by one or more of the following measures:

- Reorient or relocate the receiving antenna.
- Increase the separation between the equipment and receiver.
- Connect the equipment into an outlet on a circuit different from that to which the receiver is connected.
- Consult the dealer or an experienced radio/TV technician for help.

# SHURE®

SHURE Incorporated <http://www.shure.com>  
 United States, Canada, Latin America, Caribbean:  
 5800 W. Touhy Avenue, Niles, IL 60714-4608, U.S.A.  
 Phone: 847-600-2000 U.S. Fax: 847-600-1212 Intl Fax: 847-600-6446  
 Europe, Middle East, Africa:  
 Shure Europe GmbH, Phone: 49-7131-72140 Fax: 49-7131-721414  
 Asia, Pacific:  
 Shure Asia Limited, Phone: 852-2893-4290 Fax: 852-2893-4055